

PROTRXion™

Battery User Manual

inVENTUS™
POWER

S-24V80-TRX

S-24V90-TRX

S-36V80-TRX

S-48V60-TRX



Designed & Manufactured by

inVENTUS™
POWER

Inventus Power, Inc.
1200 Internationale Parkway
Woodridge, IL 60517

inventuspower.com
info@inventuspower.com
+1 877.423.4242

Applicable Models

Model	Part No. (CANopen)
S-24V80-TRX (w/out heater)	58571-201
S-24V90-TRX (w/out heater)	57481-201
S-36V80-TRX (w/out heater)	58946-301
S-48V60-TRX (w/out heater)	58560-501

Document Information

Release Date	Revision	Scope of Change
2023-07-28	V2.7	Minor edits to version 2 release

Environmental Regulations

The battery pack is compliant with the following environmental regulations:

- EU Directive 2002/95/EC for Restriction of Hazardous Substances (RoHS)
- EU Directive 2006/66/EC on batteries and accumulators and waste batteries and accumulators
- EU Directive 1907/2006 on the Registration Evaluation Authorization and Restriction of Chemicals (REACH)
- Management Methods for Controlling Pollution Caused by Electronic Information Products Regulation (China RoHS)



Please read all contents of this User’s Manual prior to the installation of Inventus Power PROTRXion™ Batteries.

DOCUMENT NOTICE: The information contained in this manual is the property of Inventus Power and is subject to change without notice. Inventus Power reserves the right to make changes in the design of its products or components as progress in engineering and manufacturing may warrant. It is the customer’s responsibility to satisfy itself as to whether the information contained herein is adequate and sufficient for a user’s particular use. It is the further responsibility of each user to ensure that all applications of Inventus Power products are appropriate and safe based on conditions anticipated or encountered during use. This document does not create any additional obligation for Inventus Power and does not constitute additional warranties and representations.

Technical Support: For any issues, please email tech_support@inventuspower.com

Inventus Power® and PROTRXion™ are trademarks of Inventus Power.

Copyright© 2023 Inventus Power All rights reserved.

Abbreviations

CANOpen	Controller Area Network Bus communication	CCCV	Constant Current Constant Voltage
J1939	Higher-layer CANbus protocol for data logging	OTC	Over Temperature Charging
OCV	Over Charge Voltage	OTD	Over Temperature Discharging
AFE	Analog Front End	TCO	Thermal Cutoff
BMS	Battery Management System	SOT	Safety Over Temperature
CC	Constant Current	SOC	State of Charge
CID	Current Interrupt Device	OCV	Open Circuit Voltage
COV	Cell Over Voltage	RT	Room Temperature
DOD	Depth of Discharge	Ah	Ampere Hour
OCC	Over Current Charge	CUV	Charge Under Voltage
LED	Light Emitting Diode		

Abbreviations	3
Safety Information	5
Personal Protective Equipment / Installation Tools	6
Unboxing the Battery	6
Mechanical Features	7
Battery Serial Number Format	7
Product Dimensions	7
Wake-Up & Ship Mode	8
Selecting Power Cables	9
Communication Cables	9
Selecting a Battery Charger	10
Connecting the Battery	11
Battery Terminal Torque Rating	11
Module Configuration	12
Adding CAN Termination Resistance	13
Communications	14
Pin Definition	15
Battery Modes	16
Battery State of Charge Indicator	17
Disconnecting the Battery	18
Battery Specifications	18
Battery Performance Data	19
Maintenance and Storage	21
Transporting Lithium-ion Batteries	22
Emergency and First Aid Procedures	24
Troubleshooting	25
Serial Number Record	27
Warranty Violations	28
Recycling	29
Technical Support	29

DO	DO NOT
<ul style="list-style-type: none"> • Always wear proper personal protective equipment • All installation should be performed by a qualified service technician • Use only insulative tools required for assembly • Dispose of the battery properly in accordance with local, state, and federal regulations • Extinguish any flames with a carbon dioxide, dry- powder fire extinguisher, and cover with copious amounts of water 	<ul style="list-style-type: none"> • Do not use with other types of batteries connected with the PROTRXion™ products • Do not short circuit the battery terminals • Do not operate or store the battery beyond the operating limits • Do not over-charge or over-discharge the battery • Do not crush, puncture, or drop the battery • Do not immerse battery in water • Do not burn or expose battery to fire • Do not charge battery near flammable materials, liquids, and surfaces • Do not alter, disassemble, modify, or open battery • Do not wear jewelry (i.e. rings, watches, bracelets, necklaces) when handling or working near the battery • Do not lift battery by the terminal cables • Do not operate if battery has been damaged in any way during shipping

Symbol	Definition
	Important safety information will follow.
	DO NOT dispose of battery in fire.
	RECYCLE! Battery may require recycling in accordance with local laws. Regardless, recycling is encouraged. Contact local regulatory authorities for more information. DO NOT include battery with lead acid battery recycling.
	DO NOT dispose of battery in the trash.
	Shock Hazard - Labels may be located on or inside the equipment to alert people that dangerous voltage may be present.
	Burn Hazard - Labels may be located on or inside the equipment to alert people that surface temperature may be dangerous.

Personal Protective Equipment / Installation Tools



Before installation or maintenance of your batteries, the following equipment is required:

- Rubber gloves
- Safety goggles or other eye protection
- Insulated Torque Wrench / Philips Screwdriver
- Voltmeter

Unboxing the Battery

Before You Start

Please read all the safety and warranty information provided in this document prior to installing and/or operating the battery.



IMPORTANT: Remove all jewelry or other metallic objects from your hands and body during the installation and removal of the battery packs and peripherals.

What's in the Box?

- Inventus Power PROTRXion[™] battery
- UNDOT 38.3 / IATA approved packaging
- QR Code Slip to access manuals, datasheets, and more supporting documents
- Signal connector dust covers (pre-installed on battery)
- Terminal bolts (pre-installed on battery)
- Protective battery terminal covers

Note: All power and signal cables must be purchased separately.

Unpacking

- If possible, do not discard the packaging. This packaging is designed for the safe transportation of lithium-ion batteries compliant with global shipping regulations and can be reused if the battery must be transported to a new location.

Visual Inspection

- Please inspect each battery carefully. Report any damage from shipping to Inventus Power immediately.

Mechanical Features

S-24V80-TRX / S-24V90-TRX / S-36V80-TRX / S-48V60-TRX

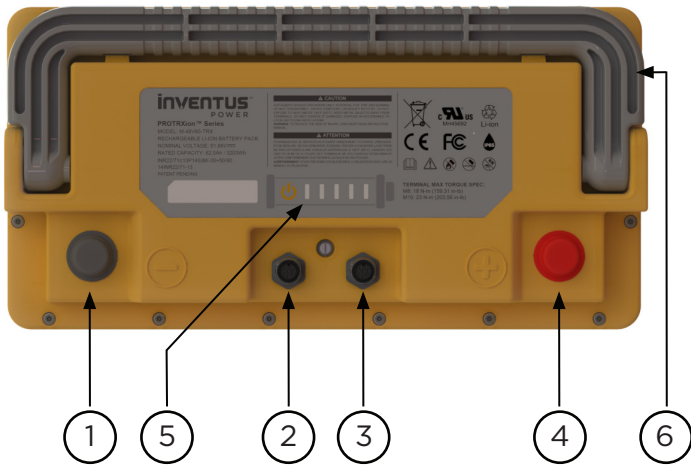

#	Description
1	Negative Terminal
2	Signal Connector #1
3	Signal Connector #2
4	Positive Terminal
5	Battery State of Charge Indicator
6	Retractable Pull Handle

Battery Serial Number Format

Battery Serial Number can be one of two distinct formats depending on the model. Inventus Power is transitioning all models to the format on the right.



FF **Factory Location** (TJ: Tijuana, MX; QX: QingXi, CH)
XXXXXXXX **SKU Part Number** (Last 8 digits)
SSSS **Battery Serial Number** (00001-65535)
YYYYMMDD **Mfg Date** (Year, Month, and Day)



F **Factory Location** (T: Tijuana, Mexico; Q: QingXi, China)
XXXXXXX **SKU Part Number** (Last 7 digits)
SSSS **Battery Serial Number** (00001-65535)
YYDDD **Mfg Date** (Year, Day of the year)

Product Dimensions

Specification	S-24V80-TRX	S-24V90-TRX	S-36V80-TRX	S-48V60-TRX
Length			346 ± 2.0mm	
Width			176 ± 2.0mm	
Height			258 ± 2.0mm	

Wake-Up & Ship Mode

TO **WAKE UP** THE BATTERY

Press the SOC button for 5 seconds

We recommend to place the battery in Ship Mode when it is not used to prevent self-consumption current drain and extend storage life.

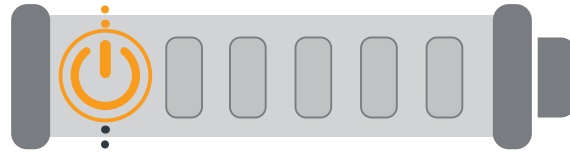

TO PLACE IN **SHIP MODE**

Press the SOC button for 20 seconds

Battery can also receive a wake up signal from the signal connector by shorting pin 4 (VGND) to pin 5 (VINTLK) to wake up battery from Ship Mode.

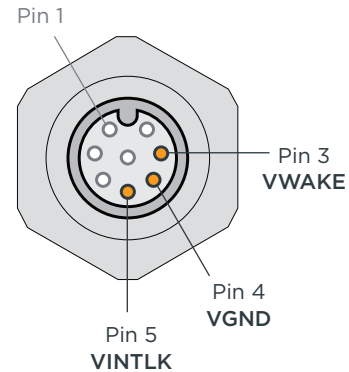
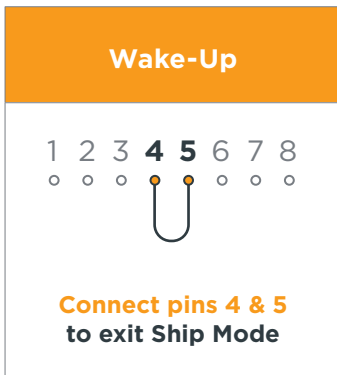

Selecting Power Cables

Choose the appropriate power cable size based on the system load requirements. Cables are rated for copper conductor at conductor temperatures under 60°C (140°F) per the table below. When connected in parallel configuration, it is preferable for all cables to be the same length and gauge.

Copper Wire Gauge (AWG)	Metric Wire Cross-Section (mm ²)	Ampacity (A)
14	2.08	15
-	2.5	21
12	3.31	20
-	4	26
10	5.26	30
-	6	34
8	8.37	40
-	10	46
6	13.30	55
-	16	61
4	21.15	70
-	25	80
2	33.62	95
-	35	98
1	42.41	110
-	50	121
0 (1/0)	53.46	125
-	70	156
00 (2/0)	67.40	145
-	70	156
000 (3/0)	85.01	165
-	95	187

Communication Cables

If your application requires communication, please connect a CAN cable to the battery signal connector and respective system or chargers.

Item	Mfg Part No.	Cable Length	Where to Purchase
Pack to Host	T4161120008-001	0.5 meter (1.64')	Digikey
Pack to Pack	903-09458-001	0.6 meter (1.97')	Inventus Power

Selecting a Battery Charger

Many types of lead acid chargers are compatible with our PROTRXion™ batteries and safely charge in temperature ranges as shown in the table below. The charger maximum voltage output should match the maximum charge voltage of the battery system and should not exceed constant voltage as shown in the table below. It is recommended to charge the battery prior to installation. Consult with Inventus Power for recommendation on selecting a battery charger.

After the charger has been selected, first connect the (-) terminal to the battery, then the (+) terminal. Once the terminals have been connected, connect the CAN communication to the battery to optimize the charger performance (preferred chargers recommended by Inventus Power).

Charge Voltage / Current

Model	S-24V80-TRX	S-24V90-TRX	S-36V80-TRX	S-48V60-TRX
Max Charge Voltage	28.0 VDC	28.0 VDC	41.0 VDC	58.1 VDC
Charge Current	40A (0.5C)	45A (0.5C)	26.4A (0.33C)	18A (0.3C)
Max Charge Current	80A (1.0C)	90A (1.0C)	40A (0.5C)	20A (0.33C)
Charge Temperature (without heater)	0°C to 55°C (32°F to 131°F)		0°C to 45°C (32°F to 113°F)	

Maintenance Charge Voltage Threshold

Battery voltage in which battery charging should activate to maintain full capacity.

Model	S-24V80-TRX	S-24V90-TRX	S-36V80-TRX	S-48V60-TRX
Maintenance Charge Voltage	26.8 VDC	26.8 VDC	40.0 VDC	56.0 VDC

Charger Current

Max charge current rate will vary depending on ambient temperature and battery state of charge. Charging above the recommended current rate may impact the battery cycle life. For more detailed information on charging profile, please discuss with Inventus Technical Support.

When choosing an intelligent charger, please discuss with Inventus Technical Support on suitable off-the-shelf charger solutions.

Connecting the Battery



CAUTION: Do not connect batteries with reversed battery leads i.e. with the pack positive terminal connected to the source or system negative terminal or the pack negative terminal connected to the source or system positive terminal. Failure to follow proper connection sequence can damage the battery and void the warranty.

1. Remove power to the vehicle/device prior to installation of the PROTRXion™ battery.
2. Remove all other batteries from the system prior to replacing them with PROTRXion™ batteries.
3. Ensure the PROTRXion™ battery is in Ship Mode to remove power for safe install.
4. Remove the protective battery terminal covers from the terminals. Retain these covers in the event that you need to remove or move the battery at some future time.
5. Attach the negative cable from the device to the negative terminal on the battery.
6. Attach the positive cable from the device to the positive terminal on the battery.
7. Attach M12 communication cables between batteries if more than one battery and from battery to host system if the host system requires CANbus communication. Connect communication cables to the TE M12 connector on the battery with 0.60 Nm [6.1 kgfcm] or less torque in order to maintain good connection and avoid damaging the battery.
8. If the battery charger is integrated with the device drawing power from the PROTRXion™ battery, then please follow manufacturers recommended sequence for each battery connection.
9. It is recommended to fully charge and fully discharge the battery system upon initial connection to properly calibrate the SOC.

Please contact Inventus Technical Support if the system requires more than 6 batteries.

Battery Terminal Torque Rating

Model	Terminal Type	Wrench Size	Torque (Nm)
S-24V80-TRX S-24V90-TRX	ISO M8 x 1.25 x 20mm Bolt (Negative Terminal)	13mm	17 ± 1
S-36V80-TRX S-48V60-TRX	ISO M10 x 1.5 x 20mm Bolt (Positive Terminal)	17mm	22 ± 1

Feed terminal bolt (A) through lock washer (B), then flat washer (C), followed by power cable ring terminal (D) before threading into battery terminal as shown in the image to the right.

CAUTION: When using bolts to engage the battery's threaded holes, use the appropriate number of flat and lock washers to allow for as much thread engagement as possible without bottoming out the bolt. Over-tightening battery terminal bolts could result in damage to battery terminals. Under-tightening battery terminals could result in excessive heating of the terminals.

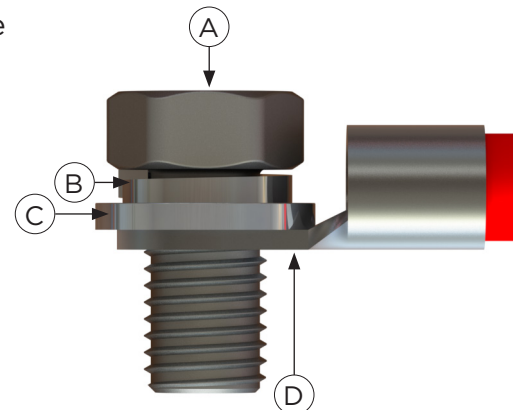

Adding CAN Termination Resistance

Note: Battery pack signal pins between connectors are connected in parallel internally within the battery pack to each other and the BMS (see below figure). CAN lines in the battery pack DO NOT have internal termination resistance. It is recommended to properly terminate the system and battery CAN Bus lines following the CAN Bus termination standards. For any technical questions about properly adding termination resistance, please contact technical support at tech_support@inventuspower.com.

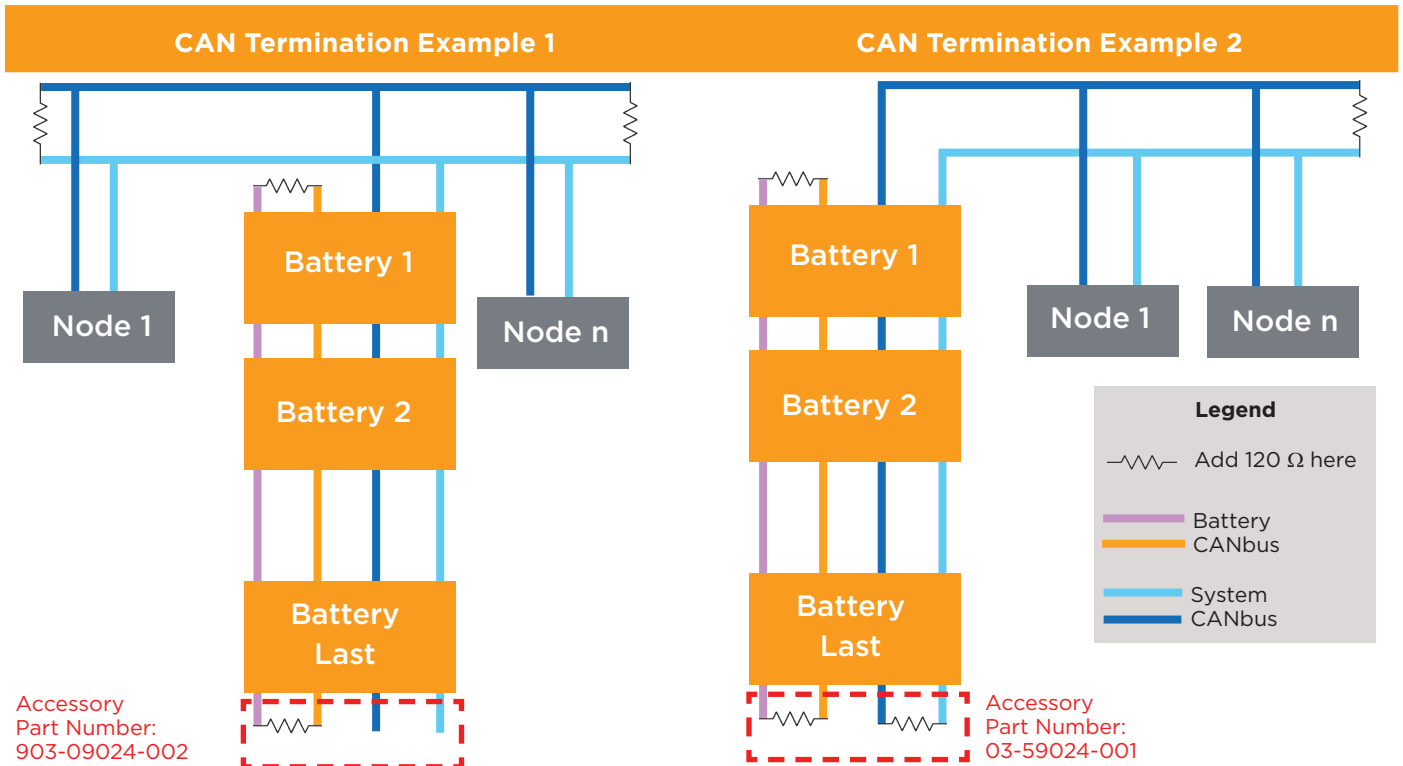
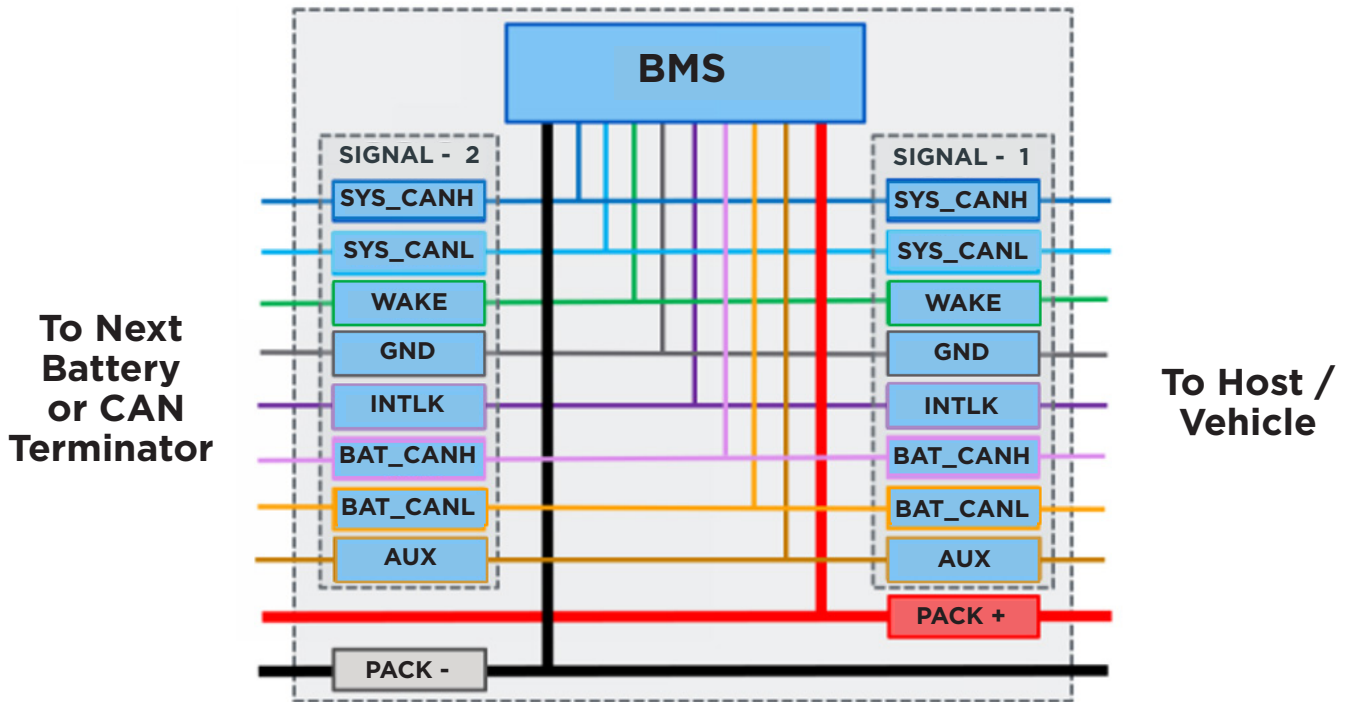

- Each PROTRXion battery uses two female Tyco Electronics M12 connectors to support signal communication with the host system.
- Communications are disabled until the battery is awake.
- Voltage, current, temperature, capacity, cycle count, state of charge, and fault codes can be read from the battery using CANopen or J1939 communication. Communication protocol of the battery is dependent on part number not model name.
- A signal interface is used as the communication interface between the battery and a connected device.

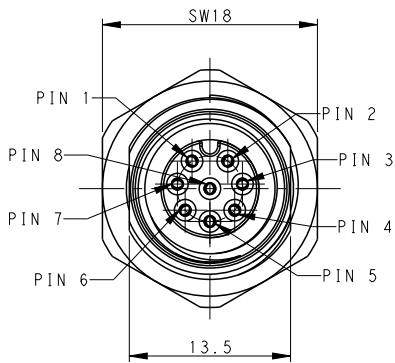

TE Connector P/N: T4131012081-000

If in doubt, please consult with **Inventus Power Technical Support** (tech_support@inventuspower.com) on further instructions on the signal cable connections to the host system.



Warning: Do not connect signal ground (pin 4) to battery pack terminal ground (-). Connecting the signal ground improperly can damage the battery and void the warranty.

Pin Definition (S-24V80-TRX / S-24V90-TRX / S-36V80-TRX)

Pin #	Symbol	Description
1	VCANH	CAN High for communication to the vehicle/machine
2	VCANL	CAN Low for communication to the vehicle/machine
3	VWAKE	Wake up input pin - active low to enable discharging
4	VGND	Pack signal ground used to pull Wake up and Interlock low
5	VINTLK	Interlock input pin - active low to enable charging
6	VCANH_BATT	CAN High for module to module communications
7	VCANL_BATT	CAN Low for module to module communications
8	VSUPPLY	Unregulated 24V/36V output - 2A continuous max.

Note: VSUPPLY 24V/36V is always on except for during Ship mode and, Over/Under Temperature and Cell Undervoltage Conditions.

Pin Definition (S-48V60-TRX)

Pin #	Symbol	Description
1	VCANH	CAN High for communication to the vehicle/machine
2	VCANL	CAN Low for communication to the vehicle/machine
3	VWAKE	Wake up input pin - active low to enable discharging
4	VGND	Pack signal ground used to pull Wake up and Interlock low
5	VINTLK	Interlock input pin - active low to enable charging
6	VCANH_BATT	CAN High for module to module communications
7	VCANL_BATT	CAN Low for module to module communications
8	VSUPPLY	Aux Power Supply (15V, <15mA current limit)

Note: Pins 6 and 8 are swapped for S-48V60-TRX models manufactured prior to March 1st, 2023.

Battery Modes

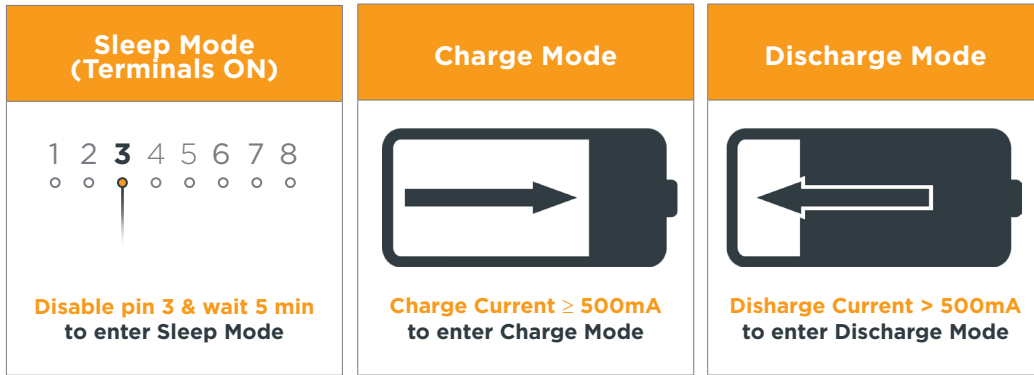

Mode Name	VWAKE	VINTLK	Action	Mode Description
Sleep (Terminals ON)	Off (Open)	Off (Open)	Disable pin 3 and wait 5 minutes to enter Sleep Mode	Sleep, Terminals ON, MOSFETs closed
Charge	N/A	N/A	Charge current $\geq 500\text{mA}$ to enter charge mode	Charge allowed*, MOSFETs closed
Discharge	N/A	N/A	Discharge current $> 500\text{mA}$ to enter discharge mode	Discharge allowed**, MOSFETs closed
Ship	N/A	N/A	Press the SOC button and hold for 20 sec to place in Ship Mode	Low power mode, MOSFETs open
Shutdown	N/A	N/A	Apply charge voltage to exit Shutdown	Lowest power mode, MOSFETs open

*Discharge also allowed in this mode unless discharge fault condition is detected in which case discharge MOSFETs are opened.

**Charge also allowed in this mode unless charge fault condition is detected in which case charge MOSFETs are opened.

Exiting Shutdown Mode





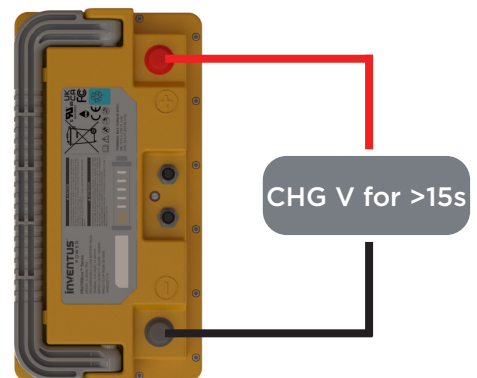

To exit Shutdown Mode, apply battery charge voltage pulse to the positive and negative terminals for >15 seconds.

Note: Many intelligent chargers sense voltage at the battery terminals prior to applying charge voltage and thus will not wake the battery from Shutdown Mode. In this case, it is recommended to use a power supply set to the appropriate charge voltage to wake the battery from Shutdown Mode.



Battery State of Charge Indicator

There are (5) LED and one button on each module to be used for SOC and fault indication. To the far left is the button followed by the LED to the right as shown in the figure below. The LED will be capable of representing a range for the remaining SOC. The LED will remain lit for 5 seconds after the button is pressed before turning off unless the SOC is less 10%, then the first LED will blink on and off for 10 seconds. The LED will come on when the following conditions are detected:

LED Indicator Status	Battery State of Charge
	80 - 100%
	60 - 79%
	40 - 59%
	20 - 39%
	10 - 19%
	<10%

Disconnecting the Battery



CAUTION: Failure to follow proper disconnection sequence can damage the battery and void the warranty.

1. Power off the machine/device prior to the removal of the PROTRXion™ battery.
2. If the battery charger is integrated with the device drawing power from the PROTRXion™ battery, then please follow manufacturers recommended sequence for battery disconnect.
3. Disconnect the communications cable (M12 signal connector) if one is attached.
4. Disconnect the positive cable from the positive terminal on the battery.
5. Disconnect the negative cable from the negative terminal on the battery.

Battery Specifications

Specification	S-24V80-TRX	S-24V90-TRX	S-36V80-TRX	S-48V60-TRX
Cell Chemistry	Lithium Iron Phosphate		Nickel Manganese Cobalt	
Voltage (Nominal / Max Charge)	25.6V / 28.0V	25.6V / 28.0V	36.9V / 41.0V	51.7V / 58.1V
Energy (Rated Capacity)	2.05kWh / 80Ah	2.30kWh / 90Ah	3.05kWh / 84Ah	3.20kWh / 62Ah
Continuous Current (per module)	150A	150A	80A	60A
Peak Pulse Discharge (@ 25°C and <10secs)	200A	200A	160A	140A
Cycle Life (@ 25°C and 80% DoD)	3,000 cycles	4,000 cycles	2,000 cycles	2,000 cycles
Charge Operating Temperature	0°C to +55°C		0°C to +45°C	
Discharge Operating Temperature	-20°C to +55°C			
Operating Humidity	5% to 95%			
Scalability	Parallel: 6 max			
Weight (Nominal)	18.2kg (40.1lbs)	20.4kg (45.0lbs)	19.3kg (42.5lbs)	19.0kg (41.9lbs)
Communication	J1939 / CANopen			
Certifications	UN38.3, FCC Class B, UL1642, UL2271 IEC62133, IEC62619, CE, RoHS, WEEE			

Battery Performance Data

S-24V80-TRX

Charging Performance

Test Condition: Ambient Temperature

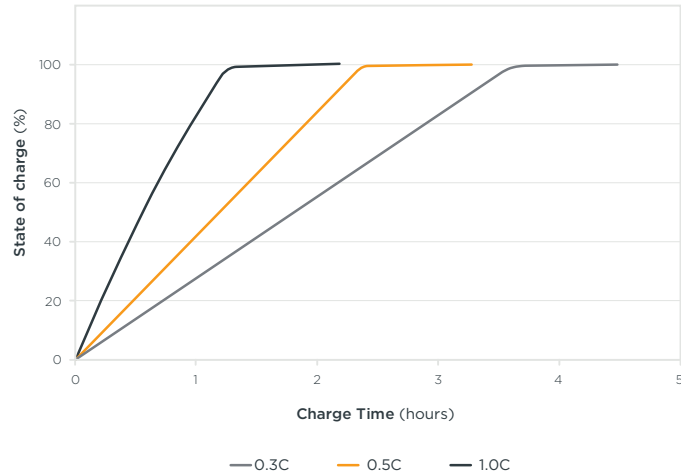

S-24V80-TRX

Capacity vs Discharge Rate

Test Condition: Ambient Temperature

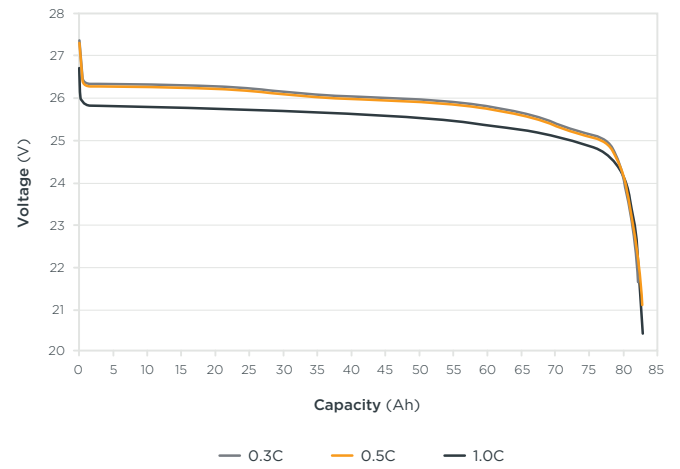

S-24V90-TRX

Charging Performance

Test Condition: Ambient Temperature

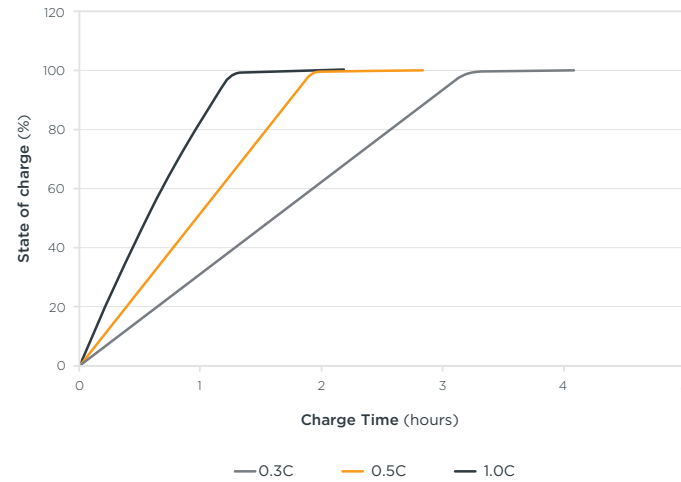

S-24V90-TRX

Capacity vs Discharge Rate

Test Condition: Ambient Temperature

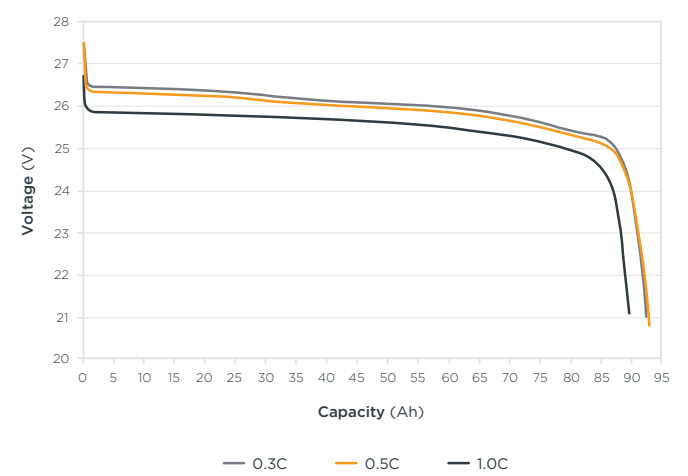

S-36V80-TRX

Charging Performance

Test Condition: Ambient Temperature

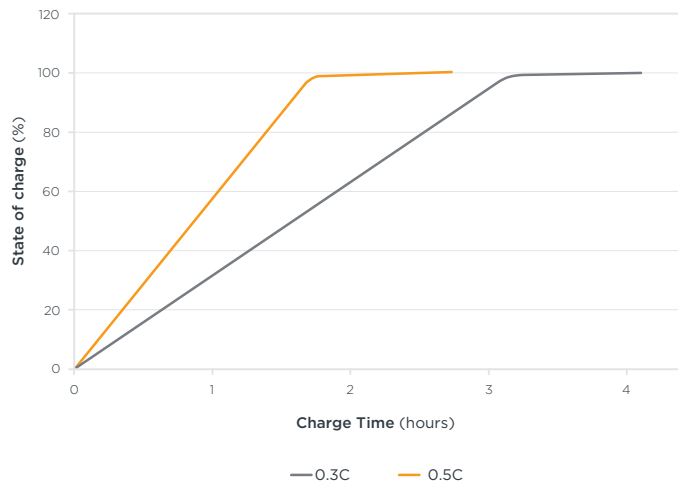

S-36V80-TRX

Capacity vs Discharge Rate

Test Condition: Ambient Temperature

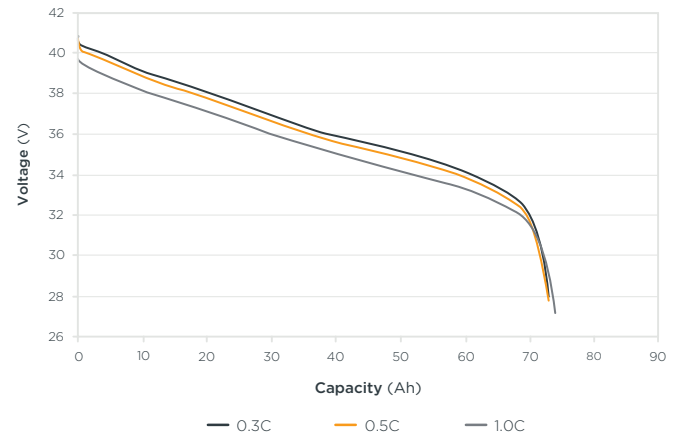

S-48V60-TRX

Charging Performance

Test Condition: Ambient Temperature

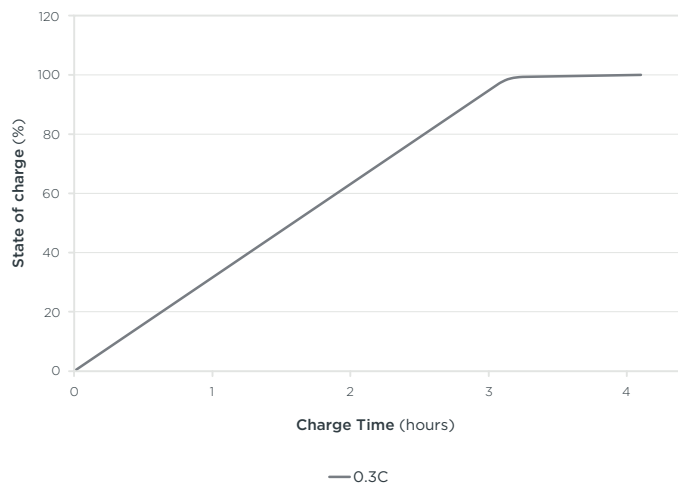

S-48V60-TRX

Capacity vs Discharge Rate

Test Condition: Ambient Temperature

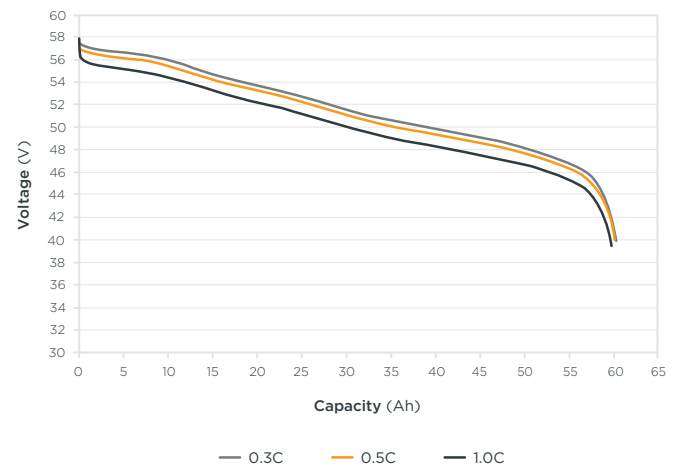

Calibration Cycle

It is recommended to charge the battery to 100% SOC after installation. A full charge and discharge cycle is recommended at least every 6 to 12 months to maintain proper SOC calibration and cell balancing.

Maintenance Charging

PROTRXion™ batteries can be stored in an environment with temperatures between -20°C (-4°F) and +60°C (140°F) and between 5% and 95% relative humidity, non-condensing. For long storage periods it is recommended to check the battery SOC every 12 months. If batteries are stored at 25°C (77°F), charge the battery every two years. For storage temperatures above 25°C (77°F), charge the battery annually. It is recommended to charge the batteries when SOC falls below 10%.

Battery Case Visual Inspection

Please perform regular visual inspections of the battery case. If the battery case is found to have dents, discoloration, or appears to be damaged in any way, DISCONTINUE USE IMMEDIATELY. Please contact Inventus Power for assistance with evaluating the product for continued usability.

Voltage Checking

The voltage of the battery can be monitored during normal operation or as part of standard tests performed periodically to assess the health of the battery. If you find the battery voltage under 20V for the S-24V80-TRX and S-24V90-TRX, under 28V for the S-36V80-TRX, or under 39V for the S-48V60-TRX at room temperature, the battery has been over-discharged or is self-discharging due to some defect/parasitic load. Discontinue use until the fault can be corrected and the battery can be recharged.

Battery Storage

- Battery should be stored between 30-50% SOC.
- Store in an open, well ventilated, and dry area <30°C for maximum life.
- Do not expose the battery to extreme temperature or sunlight over 60°C (140°F).
- Do not expose the battery to direct sunlight or moisture and/or precipitation.
- Handle each battery carefully to avoid sharp impacts or extreme pressure on the case.
- Do not store a fully discharged battery. Recharge battery after every use.

Minimum Temperature	Maximum Temperature	Duration
-20°C (-4°F)	45°C (113°F)	1 month
-20°C (-4°F)	35°C (95°F)	3 months
-20°C (-4°F)	25°C (77°F)	24 months

This section discusses the regulations governing the transportation of lithium-ion cells and batteries both within the United States and internationally. You should read and understand all relevant regulations discussed in this section before shipping Inventus Power PROTRXion™ batteries.

Lithium batteries are classified as Class 9 when transporting by air or ground. When shipping by air, all lithium batteries are required to have a 30% state of charge or less. Lithium batteries with capacity greater than 300 Wh and exceed 30kg (66lbs), are considered Class 9 when shipping by ground. For more information on shipping Lithium Batteries, please see your freight carrier's requirements.

NOTE: The regulations discussed in this manual apply to lithium-ion cells and batteries. Once the Inventus Power PROTRXion™ battery is integrated into a host system, the host may be subject to additional transportation regulations that require additional certification testing. Since Inventus Power cannot anticipate every possible configuration and application, you must verify that your system integrated with our PROTRXion™ battery system is compliant with all local ordinances and regulations.

Transporting Batteries for Installation

- Place the battery terminal protective caps on the battery terminals prior to removing the battery from its current location, to prevent accidental shorts or arcing from occurring if a terminal touches a metal object.
- Battery handle must be in the close position prior to assembly.
- Avoid heavy vibration during transportation.
- Avoid throwing, dropping, rolling and excessive stacking during loading and transportation.
- Make sure that all cables and external connectors are disconnected and properly removed from the battery prior to transporting it.
- Do not hang or hook battery handle with sharp device or at one corner only.

Transporting Batteries to a Different Location

If the battery needs to be shipped to a different location or sent back to Inventus Power for any reason:

1. Disconnect all cables, both power and communications from the batteries.
(reference section "Disconnecting the Battery" for proper disconnection procedure)
2. Place the protective caps on the battery terminals prior to removing the battery from its current location, to prevent accidental shorts or arcing from occurring if a terminal touches a metal object.
3. All large lithium-ion batteries are considered "Dangerous Goods" by the US Department of Transportation, and as a result, transporting them by common carrier (whether by ground or by air) requires compliance with UN DOT regulations UN3480, Class 9 - "Dangerous Goods".
4. Pack the batteries in "Dangerous Goods" certified boxes and packaging materials as specified by the Department of Transportation (DOT). The packaging must protect the contents from reasonable handling damage and prevent short circuits from taking place. Ideally, one would use the original box if it's still in good condition.
5. The package should be prepared for shipment and shipping documents should be signed by an individual who is certified to handle and prepare the paperwork and products that have been designated as "Dangerous Goods" for shipment.



IMPORTANT: Each PROTRXion™ battery is shipped in a specially designed box to provide maximum protection for the contents. We strongly recommend that you save this box and use it whenever you need to transport or ship the battery. Please follow all local laws/regulations regarding the shipment of lithium-ion batteries.

Following UN and DOT Regulations

Failure to comply with UN and DOT regulations while transporting Class 9 Hazardous Materials (Dangerous Goods) may result in substantial civil and criminal penalties.

Emergency Procedures for a Smoking Battery

- If a battery begins to smoke or melt, remove charging source immediately.
- If possible, move the battery to a well-ventilated area, preferably outside.
- Submerge in water or douse with copious amounts of water.

First Aid Procedures for Human Contact/Exposure to Battery Content

In the event of exposure to battery contents, the following could occur:

- Vapor or mist could irritate eyes, mucous membranes and/or respiratory tract
- Irritation to eyes and skin
- Exposure can cause nausea, dizziness or headache.

In case of contact with the battery's electrolyte:

- Immediately flush eyes with copious amounts of water for at least 15 minutes
- Assure adequate flushing of the eyes by separating the eyelids with fingers
- Flush skin with water
- Remove and wash contaminated clothing promptly
- If inhaled, remove oneself to fresh air
- If swallowed, wash out mouth with water
- If not breathing or having difficulty breathing, seek first aid

Despite the high reliability of the PROTRXion™ battery, you may encounter situations where the battery module does not operate as expected. These situations are typically the result of misuse, abuse or a non-optimal operating or storage environment. If the battery is not operating correctly, you will need to perform the following troubleshooting procedures to fix the issue.

Fault ID	LED Status	Description of Fault	Fix
F0		Over-temperature (cells)	Wait for temperature to drop into acceptable operating range
F1		Over-temperature (BMS)	Wait for temperature to drop into acceptable operating range
F2		Under-temperature (charge)	Wait for temperature to drop into acceptable operating range
F3		Over-current (recoverable)	If charging, power cycle charger; replace charger if problem persists. If discharging, battery will resume operation after discharge has been stopped.
F4		Over-current (permanent fault)	Disconnect and replace battery.
F5		Short-circuit	Check all connection point to battery system.
F6		Cell under-voltage during discharge only	Recharge battery.
F7		Cell over-voltage during charge only (primary)	Discharge battery down to 20% SOC and then recharge battery.
F8		Cell over-voltage during charge only (secondary)	Disconnect and replace battery.
F9		Safety under-voltage	Recharge battery.
F10		Cell pre-charge fault	Power cycle charger and replace charger if problem persists
F11		Charge fault	Power cycle charger and replace charger if problem persists.
F12		Under-temperature (discharge)	Wait for temperature to rise into acceptable operational range.
F13		Miscellaneous fault	Power cycle battery. Replace battery if problem persists
F14		Pre-discharge	Enable the battery without load and check if fault goes away. If fault is not present, reconnect to system. If fault persists, disconnect and replace battery.
F15		Permanent fault	Disconnect and replace battery.

Troubleshooting (CANopen Faults)

In addition to the LED fault codes, PROTRXion™ batteries have both charge and discharge faults available to be read over CAN communication. The Inventus Power Smart Battery Monitor reads and displays these faults per the table below. CAN messages follow the SW User Guide.

Charge Faults:

Fault ID	Description of Fault	Fix
C00	Over-temp (charge)	Wait for temperature to drop into acceptable operating range
C01	Under-temp (charge)	Wait for temperature to rise into acceptable operating range
C02	Over-current (recoverable)	Power cycle charger; replace charger if problem persists.
C03	Cell over-voltage (secondary)	Discharge down to 20% SOC; then recharge.
C04	Short-circuit	Check all connection point to battery system. Ensure system is compatible with battery pack.
C05	Charge fault (other)	Power cycle charger and replace charger if problem persists.
C06	Over-temp (BMS)	Wait for temperature to drop into acceptable operating range.
C07	Safety under-voltage	Disconnect and replace battery.
C08	AFE communication fault	Disconnect and replace battery.
C09	Hardware over-voltage (secondary)	Disconnect and replace battery.
C10	N/A	N/A
C11	Pre-charge fault	Power cycle charger and battery; If problem persists replace both.
C12	Parallel pack error	Check connections between batteries.
C13	N/A	N/A
C14	Pre-discharge fault	Enable the battery without load and check if fault goes away. If fault persists, disconnect and replace battery.
C15	Internal communication fault	Disconnect and replace battery.

Discharge Faults:

Fault ID	Description of Fault	Fix
D00	Over-temp (cells)	Wait for temperature to drop into acceptable operating range
D01	Under-temp (cells)	Wait for temperature to rise into acceptable operating range
D02	Over-current (recoverable)	Battery will resume operation after discharge has been stopped.
D03	Cell under-voltage (primary)	Recharge battery.
D04	Short-circuit	Check all connection point to battery system. Ensure system is compatible with battery pack.
D05	Discharge fault (other)	Power cycle battery and replace battery if problem persists.
D06	Over-temp (BMS)	Wait for temperature to drop into acceptable operating range.
D07	Safety under-voltage	Disconnect and replace battery.
D08	AFE communication fault	Disconnect and replace battery.
D09	Hardware over-voltage (secondary)	Disconnect and replace battery.
D10	N/A	N/A
D11	N/A	
D12	Parallel pack error	Check connections between batteries.
D13	N/A	N/A
D14	Pre-discharge fault	Enable the battery without load and check if fault goes away. If fault persists, disconnect and replace battery.
D15	Internal communication fault	Disconnect and replace battery.

Serial Number Record



Please record both the serial number and date of purchase and store this in a safe place for future reference.

Serial Number		Date of Purchase	
Serial Number		Date of Purchase	
Serial Number		Date of Purchase	
Serial Number		Date of Purchase	
Serial Number		Date of Purchase	
Serial Number		Date of Purchase	
Serial Number		Date of Purchase	
Serial Number		Date of Purchase	
Serial Number		Date of Purchase	
Serial Number		Date of Purchase	
Serial Number		Date of Purchase	
Serial Number		Date of Purchase	
Serial Number		Date of Purchase	
Serial Number		Date of Purchase	
Serial Number		Date of Purchase	
Serial Number		Date of Purchase	
Serial Number		Date of Purchase	
Serial Number		Date of Purchase	
Serial Number		Date of Purchase	

Warranty Violations



CAUTION: Performing any of the following actions will immediately void your warranty on the product and could lead to a potentially dangerous situation

1. Breaking the lid and exposing the circuit boards and battery assemblies.
2. Incorrect battery wiring and/or installation. Verify polarity at all connections with a standard voltmeter
3. Operating the battery in an environment where the temperature exceeds the specified limits.
4. Modifying or tampering with the TE M12 connector and communication interface and internal data logging functions.
5. Connecting PROTRXion battery in series configuration.
6. Incorrect battery bank sizing.
7. Verify polarity at all connections with a standard voltmeter (1) before energizing the system and (2) on batteries with threaded connections, before switching the built-in circuit breaker to the “ON” position.
8. Pairing the battery with incompatible equipment. Use of accessories not recommended or sold by the manufacturer may result in a risk of fire, electric shock, or injury to persons and will Void the Warranty.
9. Rotating the mating connector or loosening the nut on the battery M12 connectors.
10. Exceeding the maximum continuous discharge rate or charge rate can damage and void the PROTRXion battery.

Inventus does NOT cover product damage caused by mishandling or improper use per the Installation Manual, Integration Guides and Warranty, exposure to liquids, impacts from falling objects or being dropped, or attempts to repair the battery by any party other than Inventus.

The complete list of Warranty Exclusions is included in the Inventus Power Battery Warranty document.

If you believe that in the course of using the PROTRXion battery, you will conflict with any of the above listed conditions or any other safety precautions listed in this manual, please DO NOT proceed any further.

Contact Inventus Power immediately for guidance and information.

Recycling



Inventus Power batteries are recyclable and should be disposed properly. For information about recycling, please visit our website at: www.inventuspower.com/recycling/

Technical Support

If you have any technical questions regarding the PROTRXion™ battery, please contact our technical support team at:

Phone: +1.877.423.4242

E-mail: tech_support@inventuspower.com